

ASSEMBLY INSTRUCTIONS

DRAWER BASE CABINET (DB24-2, DB30-2)

CABINET PARTS LIST

A- Face Frame B-End Panels(2) D-Bottom Panel E-Back Panel
H-Toe Kick G-Drawer Parts(2)

DRAWER PARTS LIST

a-Front(2) b-Sides(4) c-Bottom(2) d-Back(2) e-Drawer Slides(2pr) f-Screws(Ø3*30-16)

HARDWARE PARTS LIST

1. Corner Braces(4) 2. Screws(Ø3.5*25-4) 3. Screws(Ø3*12-8) 4. Screws(Ø3*10-6)

STEP1

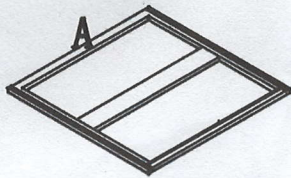

STEP2

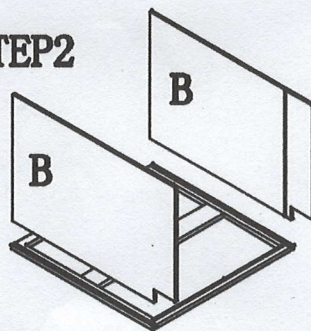

STEP3

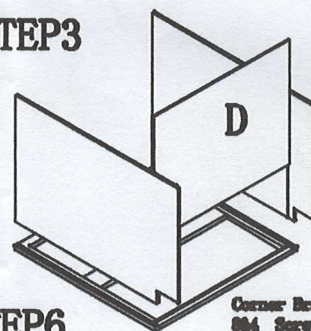

STEP4

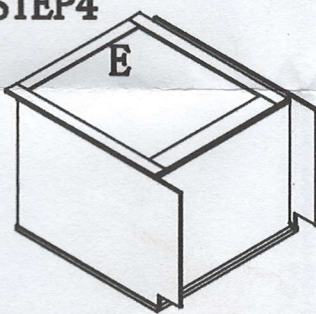

STEP5

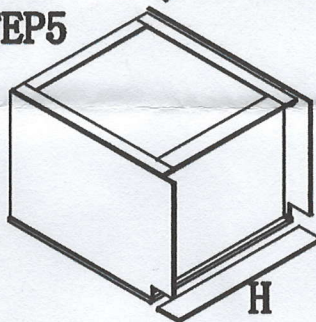

STEP6

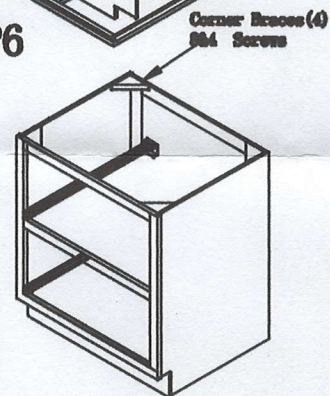

STEP7

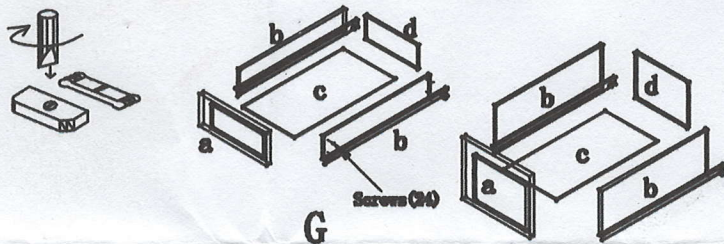

STEP8

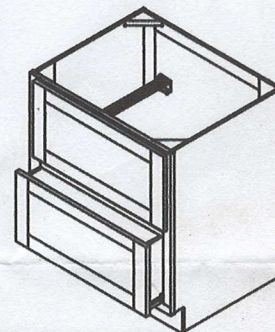

Your cabinet is complete. For installation, consult a professional contractor or building supplier for the proper installation method or materials to be used for your existing wall condition (e.g., wood, concrete, tile, etc.).